

RoHS Compliant

REV	LTR	DESCRIPTION	DATE	REVISER	SHEET
A		NEW RELEASE	2019-05-08	JIANG. REN	1/3

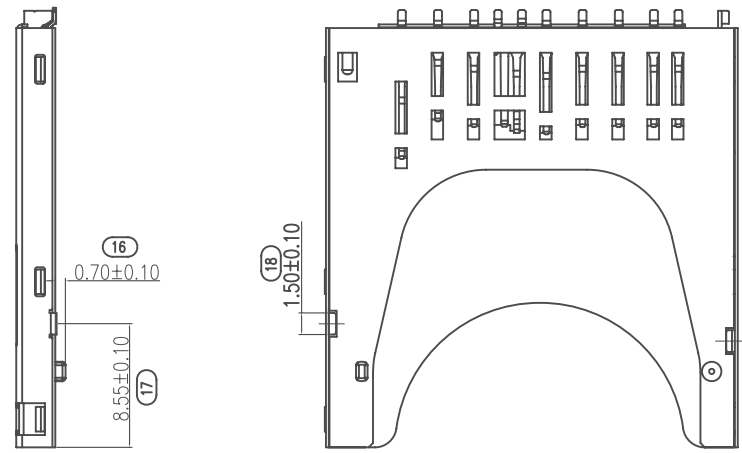
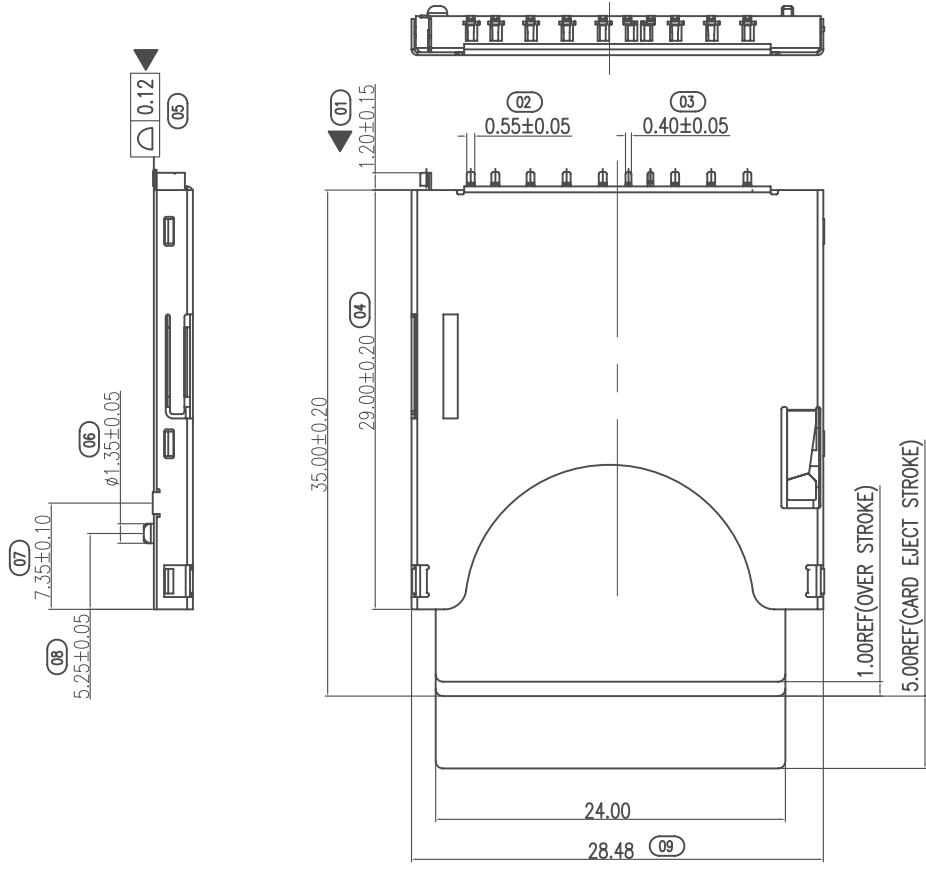

- NOTE:
- MATERIAL:
HOUSING: HIGH TEMPERATURE PLASTIC UL94V-0
COLOR : BLACK
CONTACT: COPPER ALLOY
SHELL : SUS304
 - PLATING:
TERMINAL:
CONTACT AREA: GOLD FLASH.
SOLDER AREA: MATTE TIN PLATED.
UNDER PLATE: NICKEL.
SHELL: NICKEL PLATED OVER ALL.
SOLDER AREA: GOLD FLASH.
 - PART MUST COMPLY ROHS SPECIFICATION

FrelTec GmbH

TOLERANCE	ANGLE	TITLE: SD Connector Push (Common Tape& Reel)			
.XXX ±0.10	.XXX° ±1.0°	PART NO. : 2BOSDC34HTFUBLLVYYY		DRAWING NO. : 102010142	
.XX ±0.15	.XX° ±2.0°	MOLD: XXX	SCALE: 1 : 1	UNIT: mm	SIZE: A4
.X ±0.25	.X° ±3.0°	APPROVED BY SW. MO	CHECKED BY LIANG. ZHUO	REV. A	DRAWING BY JIANG. REN

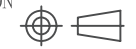

RoHS Compliant

REV	LTR	DESCRIPTION	DATE	REVISER	SHEET
A		NEW RELEASE	2019-05-08	JIANG. REN	2/3

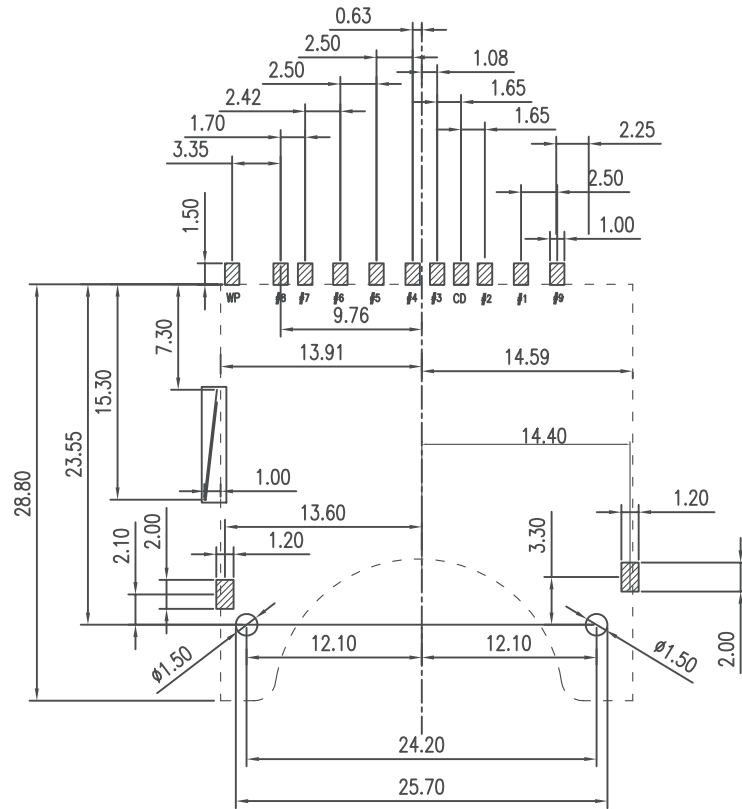

P.C.B LAYOUT

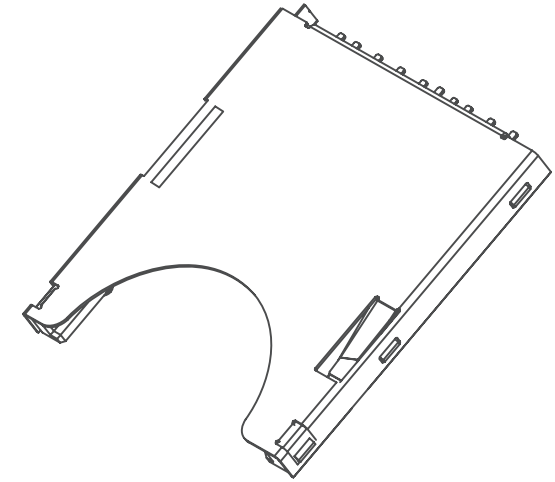

SD CARD PIN DESIGN

PIN NO.	NAME	TYPE	DESCRIPTION
#1	CD/DAT3	I/O/PP	CARD DETECT/DATA LINE(BIT3)
#2	CMD	PP	COMMAND/RESPONSE
#3	VSS1	S	SUPPLY VOLTAGE GROUND
#4	VDD	S	SUPPLY VOLTAGE
#5	CLK	I	CLOCK
#6	VSS2	S	SUPPLY VOLTAGE GROUND
#7	DAT0	I/O/PP	DATA LINE(BIT 0)
#8	DAT1	I/O/PP	DATA LINE(BIT 1)
#9	DAT2	I/O/PP	DATA LINE(BIT 2)

CIRCUIT

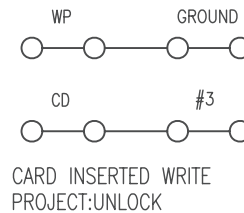
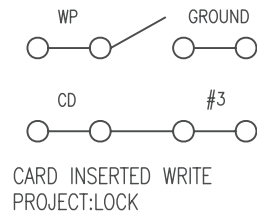
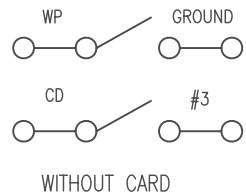

FrelTec GmbH

TOLERANCE	ANGLE	TITLE: SD Connector Push (Common Tape& Reel)			
.XXX ±0.10	.XXX° ±1.0°	PART NO. : 2BOSDC34HTFUBLLVYYY		DRAWING NO. : 102010142	
.XX ±0.15	.XX° ±2.0°	MOLD: XXX	SCALE: 1 : 1	UNIT: mm	SIZE: A4
.X ±0.25	.X° ±3.0°	APPROVED BY SW. MO	CHECKED BY LIANG. ZHUO	REV. A	DRAWING BY JIANG. REN



RoHS Compliant

REV	LTR	DESCRIPTION	DATE	REVISER	SHEET
A		NEW RELEASE	2019-05-08	JIANG.REN	3/3

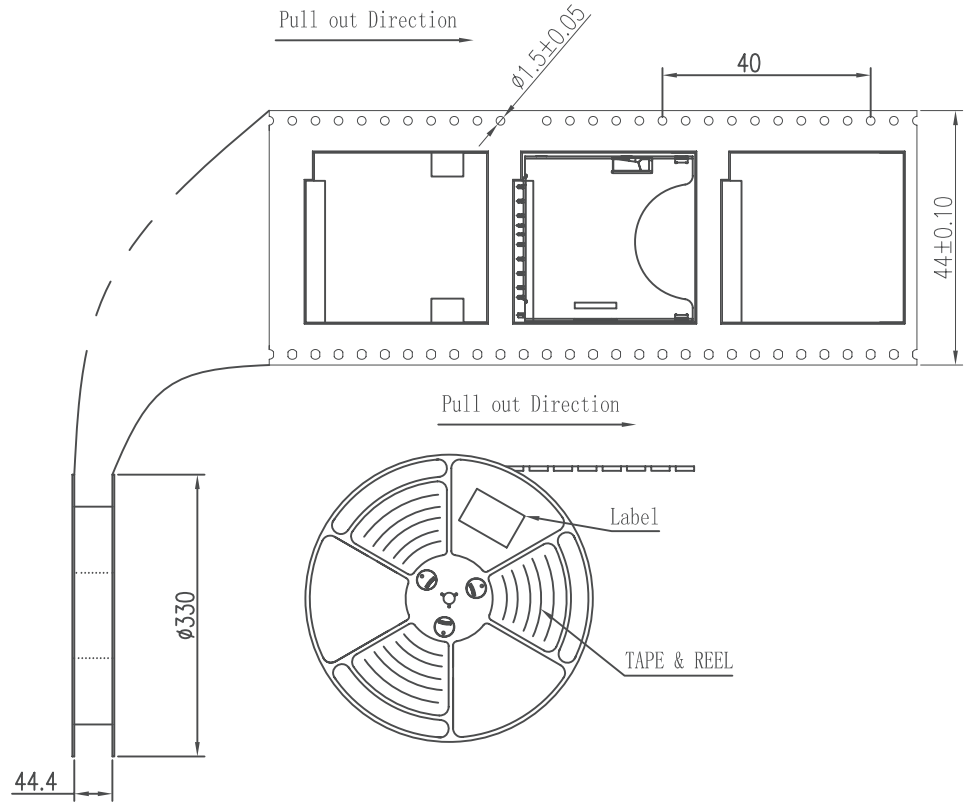

NOTES

1. Apply Dia. 330mm plastic reel
2. Quantity per reel: 350 PCS
3. Quantity per carton: 2100 PCS

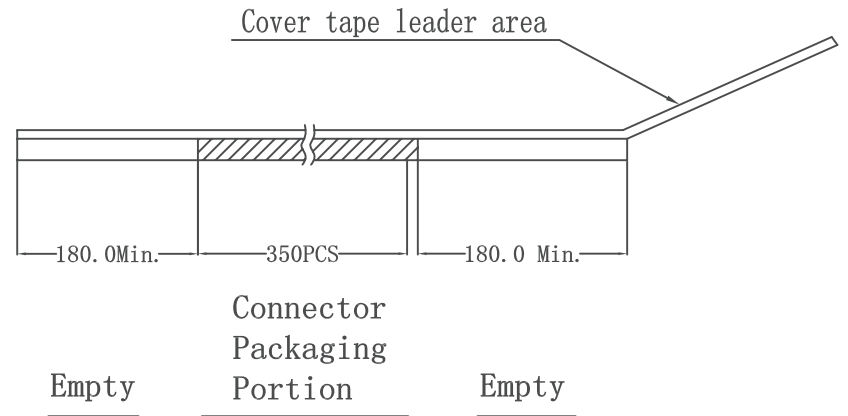

FrelTec GmbH

TOLERANCE		ANGLE		TITLE: SD Connector Push (Common Tape& Reel)				
.XXX	±0.10	.XXX°	±1.0°	PART NO. : 2BOSDC34HTFUBLLOVYYY			DRAWING NO. : 102010142	
.XX	±0.15	.XX°	±2.0°	MOLD:	SCALE:	UNIT:	SIZE:	REV.
.X	±0.25	.X°	±3.0°	XXX	1 : 1	mm	A4	A
PROJECTION				APPROVED BY		CHECKED BY		DRAWING BY
				SW. MO		LIANG. ZHUO		JIANG.REN