

FrelTec

Mathildenstr. 10A
82319 Starnberg
Germany

Surface Mount Standard Rectifier
SOD323F

SOD323F

Surface Mount Standard Rectifier

SPECIFICATION

68B	SGC61_Axxxx	S33F	E03
Type	Type	Package	Packing
68B: Surface Mount Standard Rectifier	SGC6_A	SOD323F eSGP	E03: tape in Embossed tape and reel for 3000 pc (7'REEL)

All products according to RoHS (2015/863/EU)

FrelTec

SOD323F

Surface Mount Standard Rectifier

PACKAGE OUTLINE



RoHS
COMPLIANT



eSGP(SOD-323F)

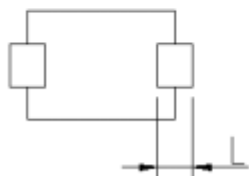
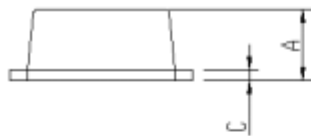
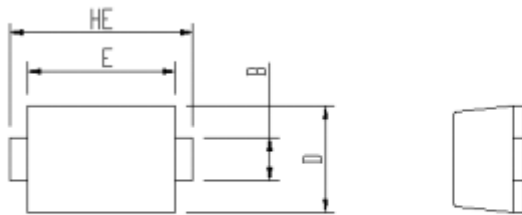

Package	Unit:mm		Unit:inch	
	MIN	MAX	MIN	MAX
eSGP				
A	0.9	1.08	0.035	0.043
B	0.5	0.7	0.020	0.028
C	0.1	0.25	0.004	0.010
D	1.4	1.6	0.055	0.063
E	2.0	2.2	0.079	0.087
L	0.35	0.65	0.014	0.026
HE	2.4	2.8	0.094	0.110

Soldering footprint

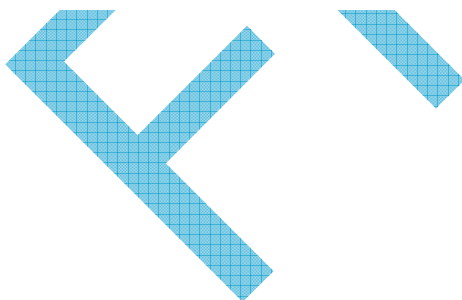
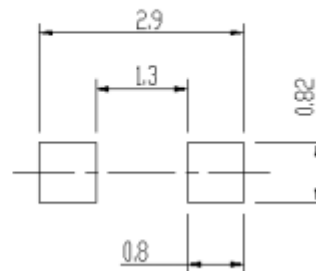

SOD323F

Surface Mount Standard Rectifier

Maximum Ratings & Characteristics

TA = 25°C unless otherwise noted

Parameter	Symbol	SGP1A	SGP2A	SGP3A	SGP4A	SGP5A	SGP6A	SGP7A	Unit
Maximum repetitive peak reverse	VRRM	50	100	200	400	600	800	1000	V
Maximum RMS voltage	VRMS	35	70	140	280	420	560	700	V
Maximum DC blocking voltage	VDC	50	100	200	400	600	800	1000	V
Maximum average forward rectified current(See Fig.1)	IF(AV)	1,0							A
Peak forward surge current 8.3 ms single half sine-wave superimposed on rated load	IFSM	25							A
Operating junction and storage temperature range	TJ, TSTG	-55 to +150							°C

Electrical Characteristics

TA = 25°C unless otherwise noted

Parameter	Test conditions	Symbol	SGP1A	SGP2A	SGP3A	SGP4A	SGP5A	SGP6A	SGP7A	Unit
Maximum repetitive peak reverse	1A	VF	1,1							V
Maximum DC reverse current at rated DC blocking voltage	TA=25°C	IR	5							uA
	TA=125°C		50							
Typical reverse recovery time	IF=0.5A, IR=1.0A, Irr=0.25A	trr	1,8							uS
Typical junction capacitance	4.0 V, 1 MHz	CJ	5							pF
Typical thermal resistance ¹⁾	junction to mount	R _{θJA} ¹⁾	55							°C /W

Note: 1)The thermal resistance from junction to mount, , mounted on P.C.B with 5x5mm copper pad area, 2 OZ, FR4

SOD323F

Ratings and Characteristics Curves

Surface Mount Standard Rectifier

TA = 25°C unless otherwise noted

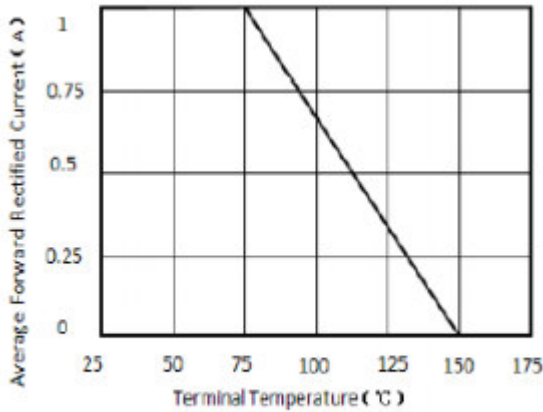

Figure 1. Forward Current Derating Curve

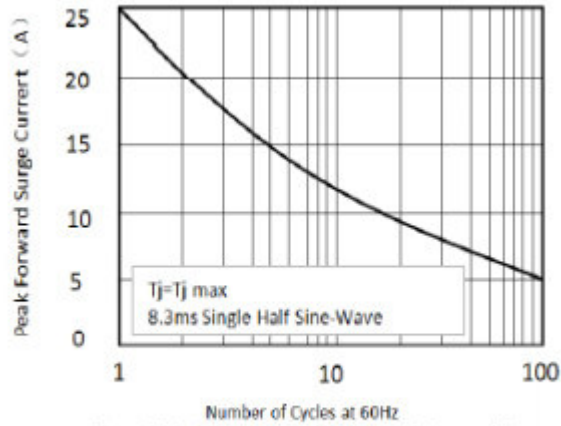

Figure 2. Maximum Non-Repetitive Peak Forward Surge Current

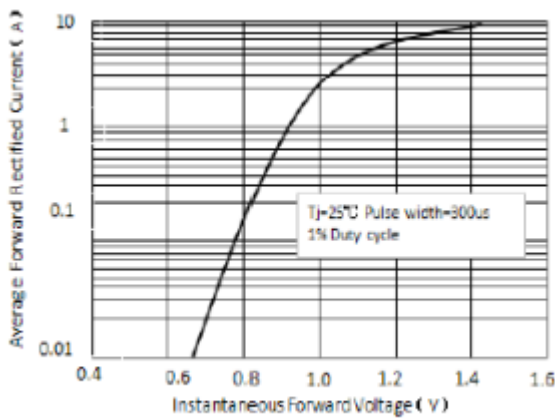

Figure 3. Typical Instantaneous Forward Characteristics

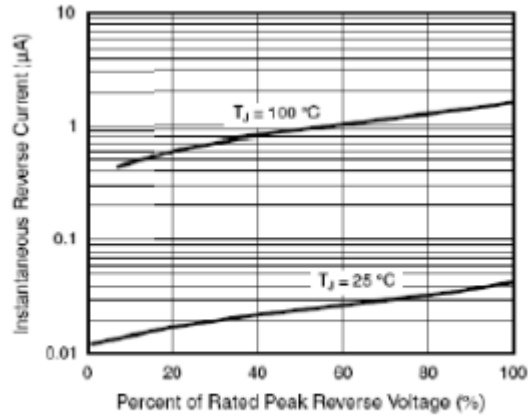

Figure 4. Typical Reverse Characteristics

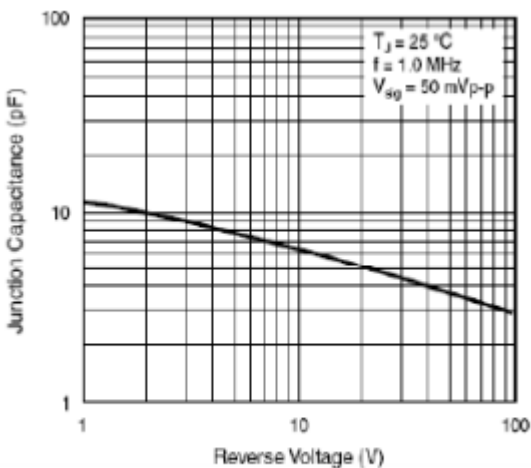

Figure 5. Typical Junction Capacitance

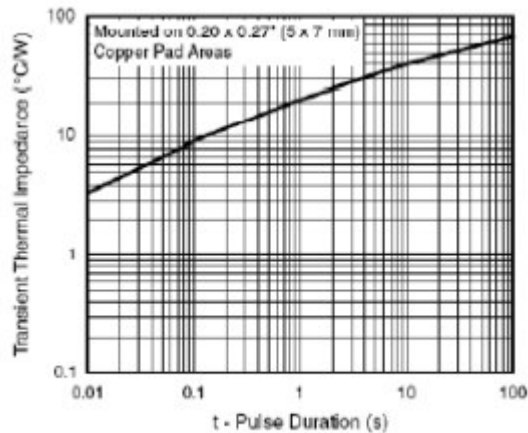
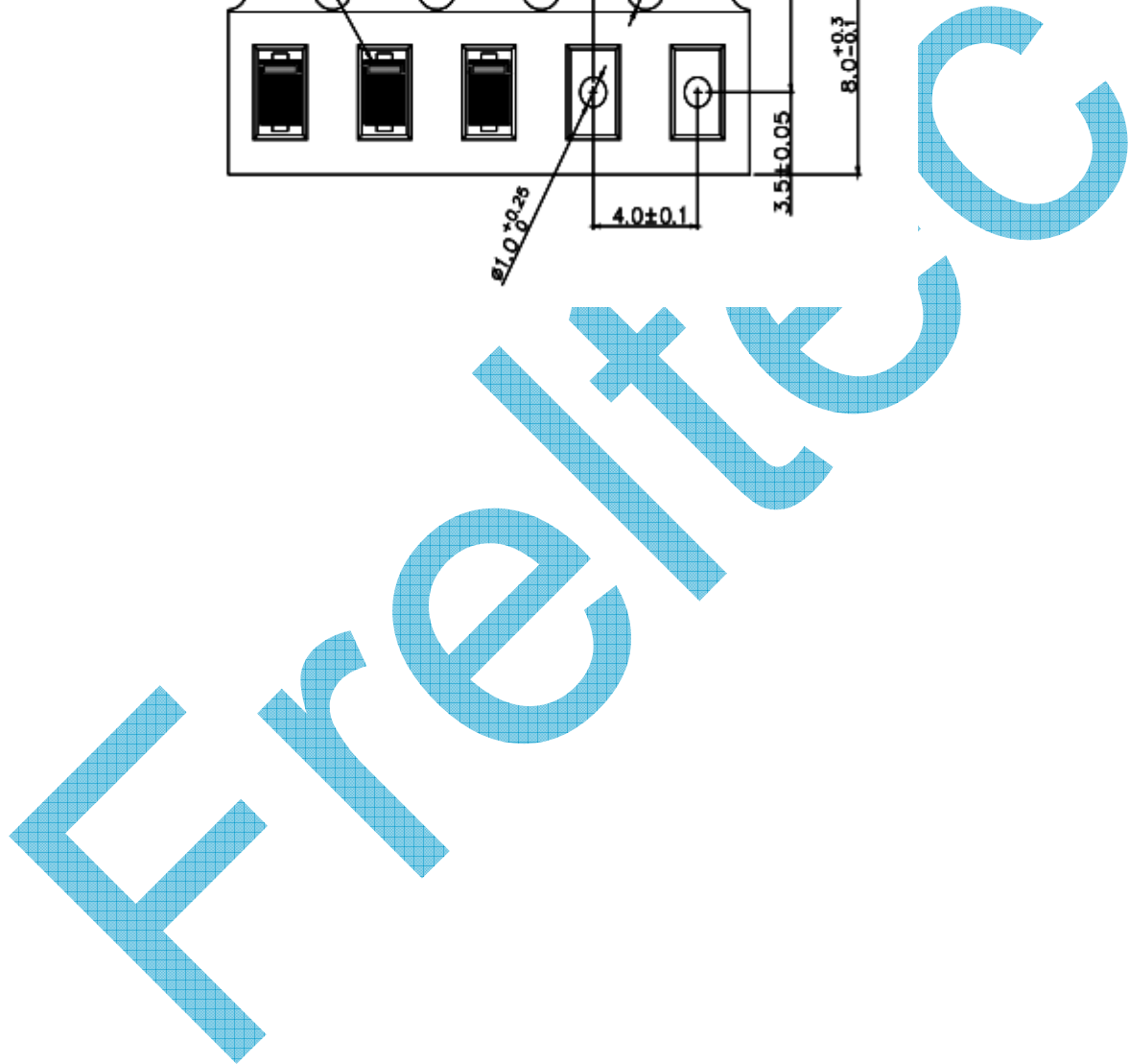
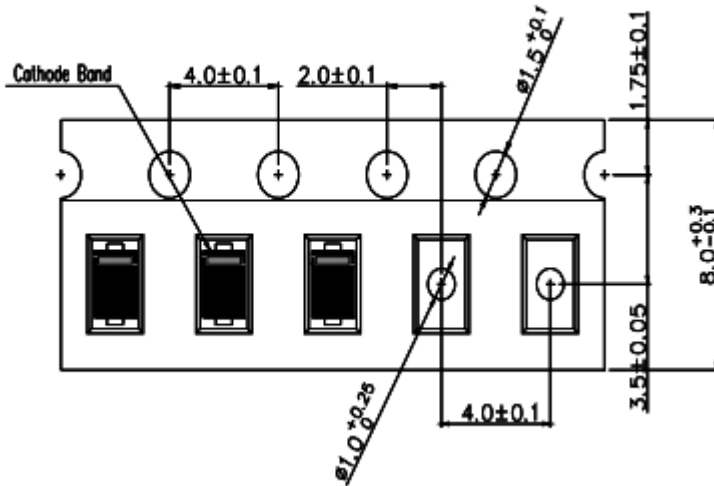

Figure 6. Typical Transient Thermal Impedance

SOD323F
SPECIFICATION

Tape And Reel Package

Tape & Reel Specification



Soldering Parameters

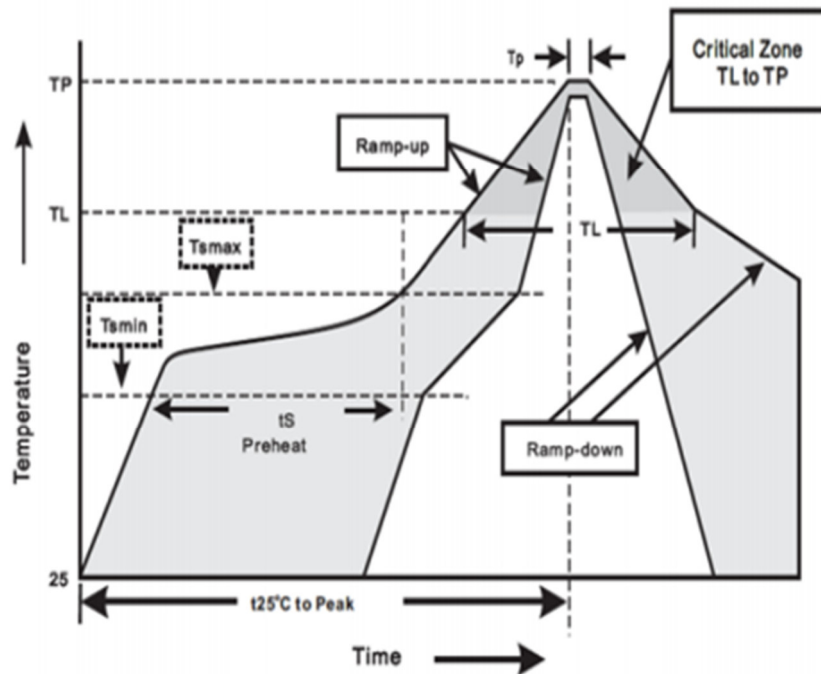

Stock period

The performance of these products, including the solderability, is guaranteed for 12 month, provided that they remain packed as they were when delivered and stored at a temperature of 20-30°C and a relative humidity 20-60%RH

SOD323F

Surface Mount Standard Rectifier

Published by FrelTec® GmbH

Mathildenstr, 10A; 82319 Starnberg; Germany

© 2021 FrelTec® GmbH, All Rights Reserved,

The following applies to all products named in this publication:

1. The information describes the type of component and shall not be considered as assured characteristics,
2. Terms of delivery and rights to change design reserved,
3. Some parts of this publication contain statements about the suitability of our products for certain areas of application, These statements are based on our knowledge of typical requirements that are often placed on our products in the areas of application concerned, Nevertheless, we explicitly point out that such statements cannot be regarded as binding statements about the suitability of our products for a particular customer application, As a rule, FrelTec® is either unfamiliar with individual customer applications or less familiar with them than the customers themselves, For these reasons, it is always ultimately incumbent on the customer to check and decide whether a FrelTec® product with the properties described in the product specification is suitable for use in a particular customer application,
4. We also point out that in individual cases, a malfunction of electronic components or failure before the end of their usual service life cannot be completely ruled out in the current state of the art, even if they are operated as specified, In customer applications requiring a very high level of operational safety and especially in customer applications in which the malfunction or failure of an electronic component could endanger human life or health (e.g. in accident prevention or life-saving systems), it must therefore be ensured by means of suitable design of the customer application or other action taken by the customer (e.g. installation of protective circuitry or redundancy) that no injury or damage is sustained by third parties in the event of malfunction or failure of an electronic component,
5. The warnings, cautions and product-specific notes must be observed,
6. In order to satisfy certain technical requirements, some of the products described in this publication may contain substances subject to restrictions in certain jurisdictions (e.g. because they are classed as "hazardous"), Useful information on this will be found in our Material Data Sheets, Should you have any more detailed questions, please contact our sales offices,
7. We constantly strive to improve our products, Consequently, the products described in this publication may change from time to time, The same is true for the corresponding product specifications, Please check therefore to what extent product descriptions and specifications contained in this publication are still applicable before or when you place an order, We also reserve the right to discontinue production and delivery of products, Consequently, we cannot guarantee that all products named in this publication will always be available,
8. Unless otherwise agreed in individual contracts, all orders are subject to the current version of the "General conditions for the supply of products and services of the electrical and electronics industry" published by the German Electrical and Electronics Industry Association (ZVEI), available at www.freltec.com,
9. As far as patents or other rights of third parties are concerned, liability is only assumed for components per se, not for applications, processes and circuits implemented within components or assemblies,
10. The trade name FrelTec® is a trademark registered or pending in Europe and in other countries,