

FrelTec

Mathildenstr. 10A
82319 Starnberg
Germany

Surface Mount Standard Rectifier
SOD123HS

SOD123HS

Surface Mount Standard Rectifier

SPECIFICATION

68B	PS3_ xxxxxx	S13H	E03
Type	Type	Package	Packing
68B: Surface Mount Standard Rectifier	PS3_	SOD123HS	E03: tape in Embossed tape and reel for 3000 pc (7'REEL)

All products according to RoHS (2015/863/EU)

FrelTec

SOD123HS

Surface Mount Standard Rectifier

PS35 thru PS36

PACKAGE OUTLINE

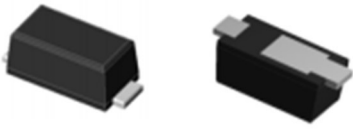

iSGA
(SOD-123HS)

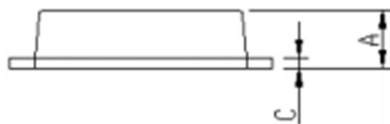
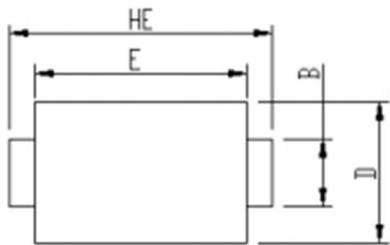
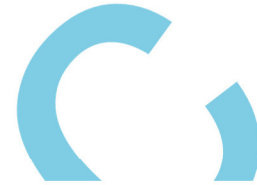

Package	iSGA	
Unit:mm	MIN	MAX
A	0.75	0.90
B	0.85	1.05
B1	0.85	1.05
C	0.1	0.25
D	1.9	2.1
E	2.9	3.1
L1	2.0	2.45
L2	0.4	0.85
L3	1.3	1.7
HE	3.5	3.9

Soldering footprint

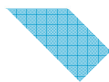
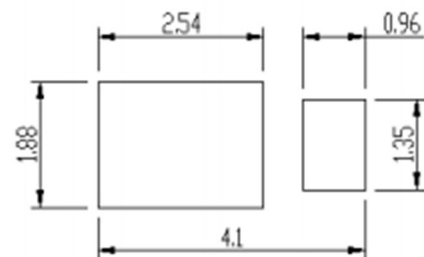
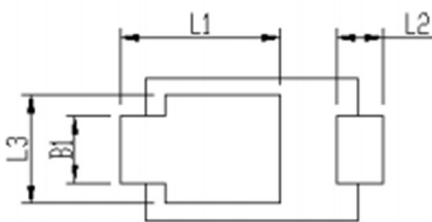

SOD123HS

Surface Mount Standard Rectifier

Maximum Ratings & Characteristics

Ratings at 25°C ambient temperature unless otherwise specified.

Parameter	Symbols	PS35	PS36	Unit
Maximum repetitive peak reverse voltage	V_{RRM}	50	60	V
Maximum RMS voltage	V_{RMS}	35	42	V
Maximum DC blocking voltage	V_{DC}	50	60	V
Maximum average forward rectified current	$I_{F(AV)}$	3,0		A
Peak forward surge current 8,3 ms single half sine-wave superimposed on rated load	I_{FSM}	100		A
Rating for fusing ($t < 8,3ms$)	I^2t	41,70		A ² sec
Operation junction temperature range	T_j	-55 to +150		°C
Storage temperature range	T_{STG}	-55 to +150		°C

Parameter	Test condition	Symbols	PS35	PS36	Unit
Minimum Breakdown voltage	$T_a = 25^\circ C$, $I_R = 1mA$	VBR	60		Volts
Maximum instantaneous forward voltage	$I_F = 3A$, $T_a = 25^\circ C$	V_F	0,61	0,65	
	$I_F = 3A$, $T_a = 125^\circ C$		0,52	0,60	
Maximum DC reverse current at rated DC blocking voltage	$T_A = 25^\circ C$	IR	4,1	50	uA
	$T_A = 125^\circ C$		3,8	10	mA
Typical junction capacitance	4,0V, 1 MHz	C_j	160		pF
Typical thermal resistance ⁽¹⁾	Junction to ambient	$R_{\theta JA}^{(1)}$	60		°C/W
	Junction to lead	$R_{\theta J}^{(1)}$	6		
	Junction to case	$R_{\theta JC}^{(2)}$	28		

Note:1).The thermal resistance from junction to ambient or lead, mounted on P.C.B with 5X5mm copper pads, 2 OZ, FR4 PCB

2).The thermal resistance from junction to case , mounted on P.C.B with recommended copper pads, 2 OZ, FR4 PCB.

SOD123HS

Characteristics(Typical)

Surface Mount Standard Rectifier

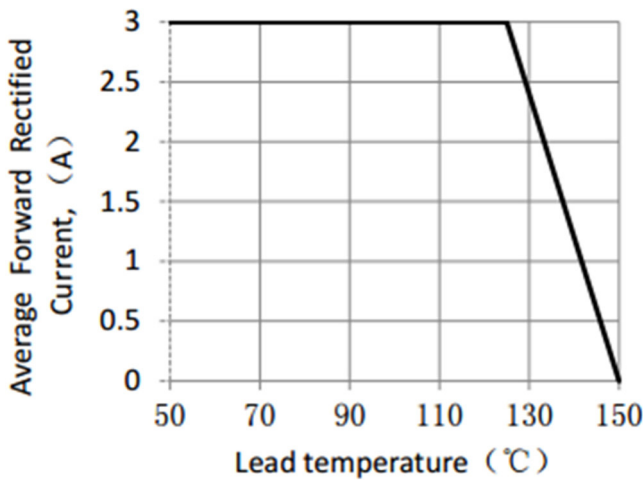

Figure 1. Forward Current Derating Curve

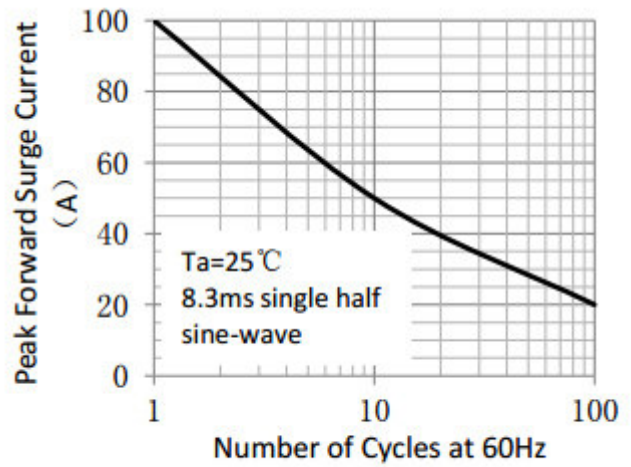

Figure 2. Maximum Non-Repetitive Peak Forward Surge Current

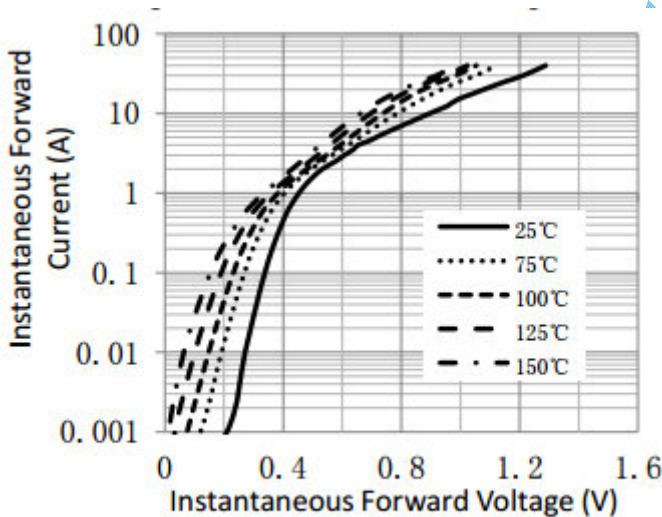

Figure 3. Typical Instantaneous Forward Characteristics

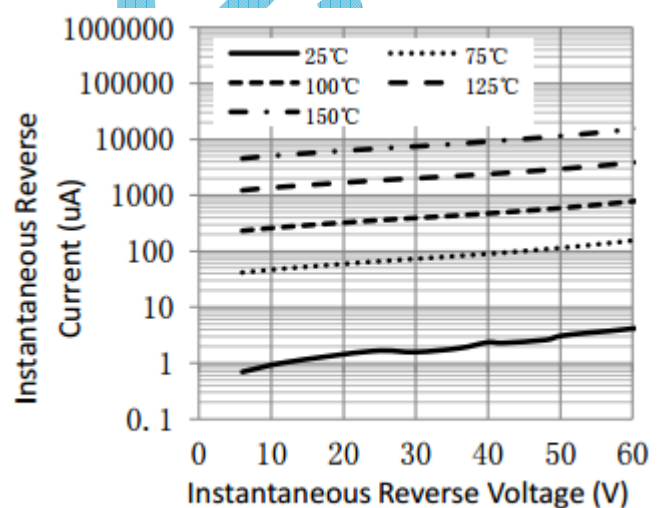

Figure 4. Typical Reverse Characteristics

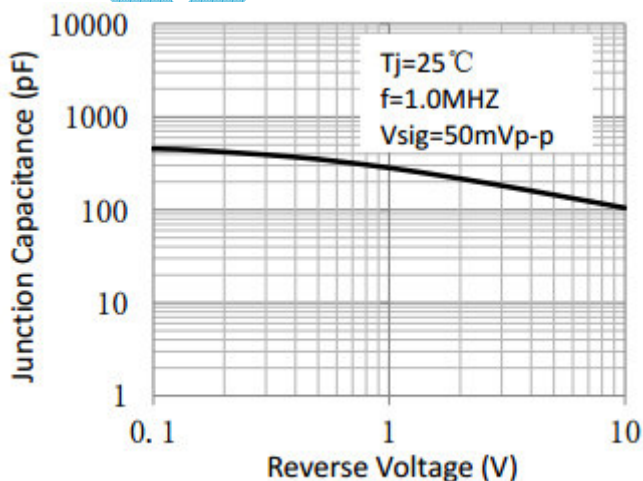

Figure 5. Typical Junction Capacitance

SOD123HS

Surface Mount Standard Rectifier

Size (Unit:mm)

Tape & Reel Specification

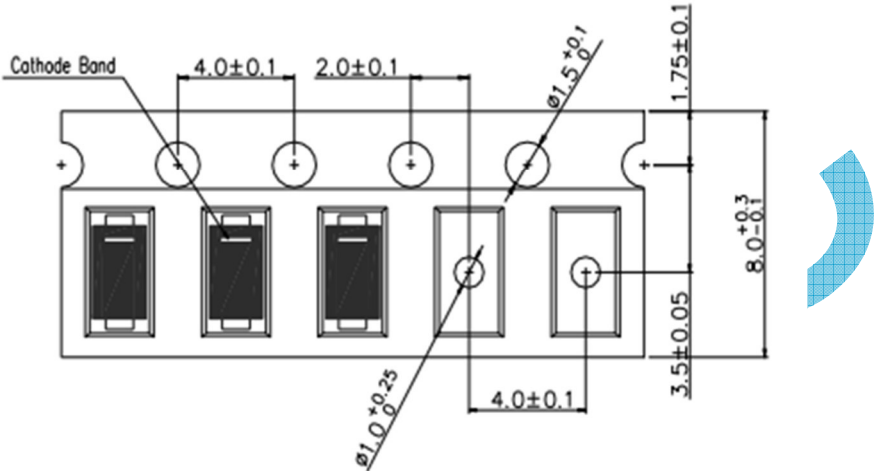

Soldering Parameters

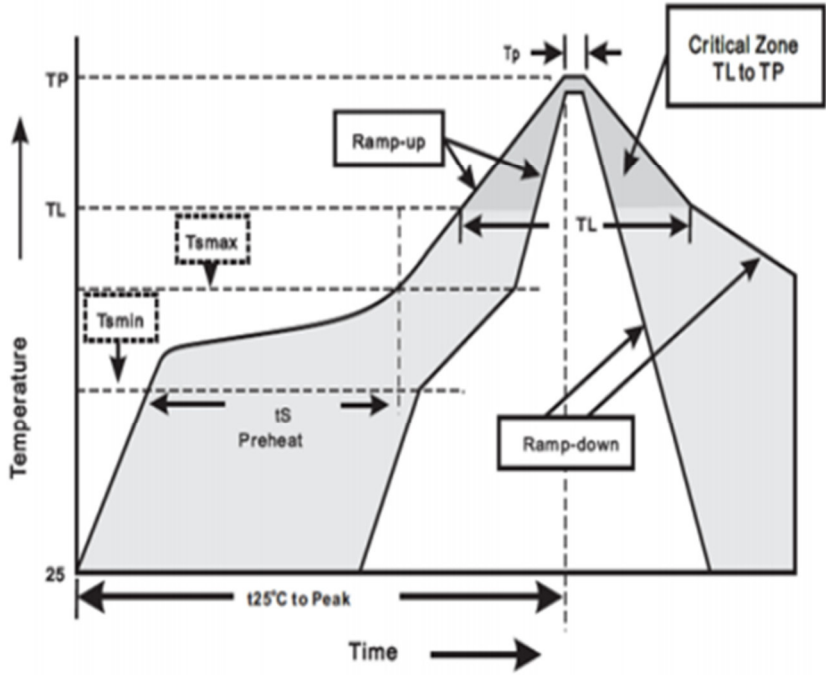

FrelTec

Stock period

The performance of these products, including the solderability, is guaranteed for 12 month, provided that they remain packed as they were when delivered and stored at a temperature of 20-30°C and a relative humidity 20-60%RH

1/30/2022

© FrelTec® GmbH

Please read cautions and warnings and important notes at the end of this document.

The following applies to all products named in this publication:

1. The information describes the type of component and shall not be considered as assured characteristics.
2. Terms of delivery and rights to change design reserved.
3. Some parts of this publication contain statements about the suitability of our products for certain areas of application. These statements are based on our knowledge of typical requirements that are often placed on our products in the areas of application concerned. Nevertheless, we explicitly point out that such statements cannot be regarded as binding statements about the suitability of our products for a particular customer application. As a rule, FrelTec® is either unfamiliar with individual customer applications or less familiar with them than the customers themselves. For these reasons, it is always ultimately incumbent on the customer to check and decide whether a FrelTec® product with the properties described in the product specification is suitable for use in a particular customer application.
4. We also point out that in individual cases, a malfunction of electronic components or failure before the end of their usual service life cannot be completely ruled out in the current state of the art, even if they are operated as specified. In customer applications requiring a very high level of operational safety and especially in customer applications in which the malfunction or failure of an electronic component could endanger human life or health (e.g. in accident prevention or life-saving systems), it must therefore be ensured by means of suitable design of the customer application or other action taken by the customer (e.g. installation of protective circuitry or redundancy) that no injury or damage is sustained by third parties in the event of malfunction or failure of an electronic component.
5. The warnings, cautions and product-specific notes must be observed.
6. In order to satisfy certain technical requirements, some of the products described in this publication may contain substances subject to restrictions in certain jurisdictions (e.g. because they are classed as "hazardous"). Useful information on this will be found in our Material Data Sheets. Should you have any more detailed questions, please contact our sales offices.
7. We constantly strive to improve our products. Consequently, the products described in this publication may change from time to time. The same is true for the corresponding product specifications. Please check therefore to what extent product descriptions and specifications contained in this publication are still applicable before or when you place an order. We also reserve the right to discontinue production and delivery of products. Consequently, we cannot guarantee that all products named in this publication will always be available.
8. Unless otherwise agreed in individual contracts, all orders are subject to the current version of the "General conditions for the supply of products and services of the electrical and electronics industry" published by the German Electrical and Electronics Industry Association (ZVEI), available at www.freltec.com.
9. As far as patents or other rights of third parties are concerned, liability is only assumed for components per se, not for applications, processes and circuits implemented within components or assemblies.
10. The trade name FrelTec® is a trademark registered or pending in Europe and in other countries.